

Galanz

REFRIGERATOR INSTRUCTION MANUAL

Model No.: GLR12TBKF
GLR12TWEF
GLR12TS5F

To ensure proper use of this appliance and your safety, please read the instruction manual completely before operating this appliance.

CONTENTS

Names of the parts	1
Safety warnings	2
Installation instructions	3
Reverse and install the doors.....	3
Operation instructions.....	7
Instruction for usage.....	7
Packing and moving.....	8
Maintenance.....	8
Defrost.....	8
Disconnecting the appliance.....	8
User notifications.....	9
Trouble shooting tips.....	9
Specifications and parameters.....	10
Packing list.....	10

- Thank for purchasing our products and thank you for placing your confidence in us.
- Please read this manual carefully before using. Follow instructions and keep it for future reference.
- Please follow the operating instructions and safety notices in the manual.
- If any trouble arise, do not fix it yourself or hand it to the after sales service center which has not been authorized. Please contact the local authorized service center.

NAMES OF THE PARTS

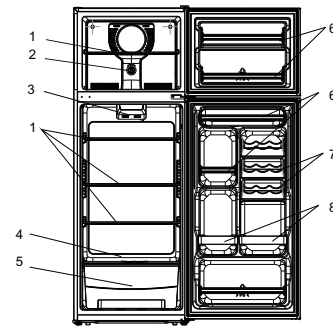

- | | |
|----------------------------------------|---------------------|
| 1. Shelves | 5. Vegetalbe |
| 2. Wind tunnel knob | 6. Rod |
| 3. Lamp and temperature Control button | 7. Cola bar |
| 4. Crisper glass cover | 8. Bottle protector |

- The refrigerator you purchased may be improved, which maybe not completely consistent with the manual. However the functions and operating methods will not change. Please feel free to use!
- If you use the refrigerator for the first time, remove the adhesive tapes of the drawers, balconies, egg tray, and the drain tube plug.
- Do not pull or push the drawers and balconies fiercely during use in case of damage.
- Adjusted the temperature control as higher as you could accept, which will save the energy consumption of the refrigerator and your money;
- Don't open the refrigerator door continually if it is in the normal working situation.
- Keep the combination of drawers, baskets and shelves of the refrigerator is consistent with its original standard.

1

SAFETY WARNINGS

For ensure your personal safety, please follow the points below:

- The circuitry for refrigerator must be isolated. The area of cross section of wire must be larger than 0.75mm². The power plug should have its own socket, the socket must be ground as adapter may cause the socket to overheat.
- The voltage and frequency of this product should be 115VAC/60Hz.
- Do stop the power only by pulling the power plug out of the socket directly but not by the wire.
- Do not damage the refrigerant circuit.
- This appliance is not intended for use by persons(including children) with reduced physical, sensory or mental capabilities, or lack of experience and knowledge, unless they have been given supervision or instruction concerning use of the appliance by a person responsible for their safety.
- Children should be supervised to ensure that they do not play with the appliance.
- Keep ventilation opening, in the appliance enclosure or in the built in structure, clear of obstruction.
- Before you throw away your old refrigerator or freezer.
 - Take off the doors;
 - Leave the shelves in place so that children may not easily climb inside.
- Do not store explosive substances such as aerosol cans with a flammable propellant in this appliance. This appliance is intended to be used in household and similar applications such as
 - staff kitchen areas in shops, offices and other working environments;
 - farm houses and by clients in hotels, motels and other residential type environments;
 - bed and breakfast type environments;
 - catering and similar non-retail applications.
- Do not use electrical appliance inside the food storage compartments of the appliance, unless they are of the type recommended by the manufacture.
- This appliance can be used by children aged from 8 years and above and persons with reduced physical, sensory or mental capabilities or lack of experience and knowledge if they have been given supervision or instruction concerning use of the appliance in a safe way and understand the hazards involved. Children shall not play with the appliance. Cleaning and user maintenance shall not be made by children without supervision.

NOTICE:

- When gas leaks from its container, don't pull the plug, out or in, for it may arouse sparks and fire calamities.
- Don't splash water on the rear of the appliance, for it may cause malfunction or electric shock.
- Don't stor inflammabe materials such as ether, benzene, LP gas and glue etc in the refrigerator.
- Don't place bottled beverage in the freezer, so as to prevent breaking.

2

- It is better not place object on the top of appliance which is magnetic, heavy, or be filled with water. Electronic components may not work steadily if water gets inside. Do not store object which is costly or impressible to temperature and , e.g. serum, bacterin and so on.
- The refrigerant of this product is R600a, which is inflammable. So, make sure not to damage the cooling system during the transportation and installation
- DISPOSAL: Do not dispose this product as unsorted municipal waste. Collection of such wastes separately for special treatment is necessary.



INSTALLATION INSTRUCTIONS

- The refrigerator should be located in a completely flat surface, Leave 5~10 cm between each side of the appliance and the wall, and leave 30 cm between the top of the appliance and the ceiling.
- Choose a location which is not exposed to sunlight, high temperature or humid, as humidity may cause stain.
- Pulled out the bottom panel before installation.
- The appliance can be adjusted by rolling its two legs in front the bottom when it is unstable. Rolling in clockwise can rise up the machine.
- The location should be firm and flat. An un-securely position may cause noise and libration:
 - The noise may be increased if the floor is not firm.
 - Put a sheet under the appliance for solving the heat emission if you need to locate it onto a carpet.
- Make sure the adjustable legs are clung to the floor, and set the appliance slope backward slightly for keeping the doors closed tightly.

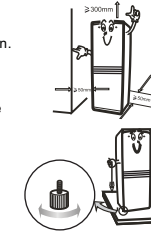

REVERSE AND INSTALL THE DOORS

You can choose to open your refrigerator by the right side or the left one. To change the way of opening, please follow the below instructions

Important safety warning: before doing so please unplug and disconnect the appliance

Except the Accessories packed, you still need :
Medium-sized cross screwdriver
Small screwdriver
A solid line

- One more person who can help you would be better.
- Firstly, you need to check if the power connect or not.
 - Open the upper door, and close the bottom door.

3

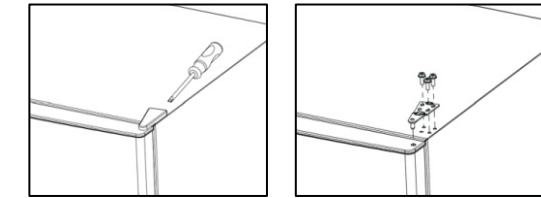

- Take off the protective covers with a Phillips screwdriver through the back side, and save the protective covers.
- Take off the 3 shelf-tapping screws, and save them.
- Push the top hinge forward, remove the door and save it aside.

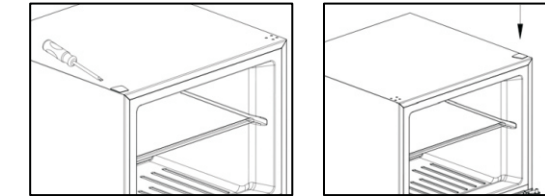

- Pry off the screw cover on the top left side of the refrigerator to uncover the screws holes.
- Replace screw cover on the top left side of the refrigerator to the right top to cover the holes. Cover si also force-fitted.

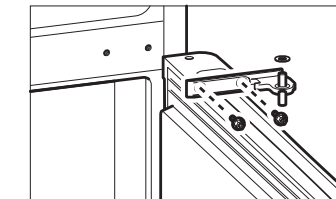

4

8. Open the bottom door.
9. Take off the 2 screws and save them.
10. Remove the middle hinge.
11. Take out the bottom door and save it.

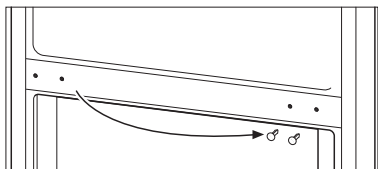

12. Pry off and remove the cover over the screw holes on the left side of refrigerator housing. Attach cover on the right side. Cover is force-fitted.

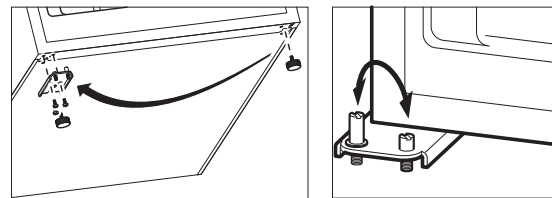

13. Slightly backward the machine against the wall.
14. Take off the 2 fixed feet.
15. Take off the bottom hinge.
16. Assemble the bottom hinge in the other side of the machine.
17. Fixed up the feet.
18. Exchange the 2 bolts and fixed them in the other sides.

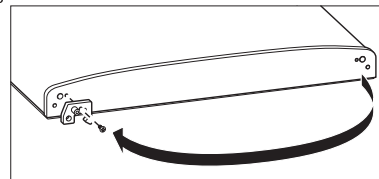

5

19. Remove the fixed plate of hinge on the bottom door, and fix it on the other side.
20. Fix up the bottom door on the outside bolts.

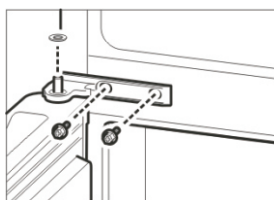

21. Fix up the middle hinge on the bottom door, position it on left side of the refrigerator and reattach with two screws.

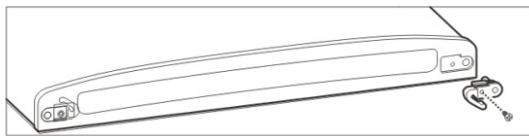

22. Take off the right door closer and fix the left closer in the other side of the upper door.

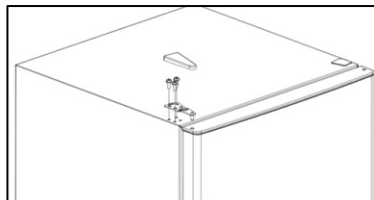

23. Place the top hinge on top of the freezer door and line up the top hinge with holes on top of the refrigerator. Use three screws to replace the hinge. Then tighten the screws. Force-fit protective covers over top hinge.

6

OPERATION INSTRUCTIONS

PLACEMENT OF FOOD

1. There should always be some space between items inside for air circulation.
2. Food should be kept in sealed package to avoid becoming dry or with odour.
3. Hot food should be cooled down before placing into the appliance. Otherwise, interior temperature and electronic consumption will increase.
4. Reduce the frequency of door opening can efficiently low down the electronic consumption.



Warning! Do not use any electronic equipment inside the appliance.

INSTRUCTION FOR USAGE

REFRIGERATOR CONTROL

The temperature of refrigerator can be controlled manually by the display. However, the number shown on the display does not directly represent the temperature. Instead, the larger the number is the lower the interior temperature will be. Initially set the refrigerator control on the middle setting (number 3). If you want to set the refrigerator temperature to a colder temperature pressing the set button until the state on 4 or 5. Each time the set button is pressed, the state increases by 1. When the state is in the highest state, press the button again and return to the first state.



FREEZER CONTROL

If the refrigerator's lower temperature is needed, please regulate the knob along the "COLDER" direction; contrarily, regulate the knob along the "COLD" direction. Note: Regulate the knob to set the freezer temperature as you desire. Always wait 24 hours after any adjustment to reach the desired temperature.

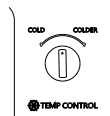

7

PACKING AND MOVING

1. Unpack, repack and carry. Please memorize the position of each accessory of the appliance when unpack it, repack the product and check it carefully before transportation.
2. Do not lift or pull the door or the door handle during transportation.
3. When moving, the appliance can not be sloped over 45 degrees (the angle to the vertical direction). Please avoid strong vibration and hit.



MAINTENANCE

The appliance should be maintained and cleaned frequently. For your safety, do please pull the plug out of the socket before the cleaning.

1. Interior maintenance. Clean the interior of the appliance with clean water or neutral abluent. Scour it with clean water and wipe it with a piece of dry cloth.
2. Maintenance of door gasket. It is easy to damage if the door gaskets are polluted by the stain like oil, sauce and etc., so it is better to clean them carefully.
3. Outer maintenance. Wipe the dusty with a piece of dry cloth, clean it with neutral abluent if necessary.

DEFROST

Defrost of refrigerator will be executed automatically during product running, so it is no requirement for manual defrost. The defrost water flows into the vaporization plate and will be vaporized by the heat of compressor. So its drain tube must be cleaned.

Warning! Do not use mechanical devices or other means to accelerate the defrosting process, other than those recommended by the manufacturer.

DISCONNECTING THE APPLIANCE

After power failure, even in summer, the refrigerator can store food normally in several hours.

1. Discontinuation during power failure. After power failure, do not put additional food in the appliance and reduce the frequency of door opening. Make several ices in a container if know the power failure beforehand, and put it in the top of the fridge.
2. Discontinuation during vacation. Please fetch out the easy-rot food and the food in fridge before shot vacation. After confirmation, close the door firmly. If have a long vacation, please fetch out all the food and cut off the power. After defrosting, clean up the liner of the appliance and wipe it dry, and leave the door open.
3. Stop using. If the refrigerator may be stopped using for a long time, please unplug the outlet and clean up the appliance. The door should be kept open in order to prevent unpleasant smell caused by food leavings.

8

Attention! In a general condition, do not stop the appliance in case of affecting its life. After unplugging the power, please leave at least 5 minutes before resumption.

USER NOTIFICATIONS

1. Do not splash water on the refrigerator, as it will cause oxidation and malfunction. Electronic component such as on/off button should be wiped dryly.
2. Cleansers such as soap powder, abrasive cleaning powder, alkali cleansers, chemical cloth, thinner, alcohol, acid petroleum product and hot water should not be used to clean the refrigerator as they may damage the painted cover and plastics.
3. Smear can damage the interior plastic component, so wipe it as soon as possible.
4. Please check the points below after maintenance:
 - (1) Is there any damage or loss of the electronic wire?
 - (2) Can the plug be put in the socket reliably and smoothly?
 - (3) Is the plug heating unconventionally?

Warning! Please get rid of the gasket of the door before the disposal. The disposed apparatus should be handled by professional staff, as it may be harmful to the environment.

TROUBLESHOOTING TIPS

1. The refrigerator does not work. It may not be connected to the power supply (plug, power cut or fuse); Voltage is too low.
2. The refrigerator does not work efficiently as expected. It may be caused by heavy frost, or by warm temperature setting, or by frequently door operating.
3. It makes unusual noise. The environment temperature may be too high. The doors may be opened frequently or even they are left open. The temperature control knob setting in (4-5) state may increase the working time of compressor.
4. The compressor keeps working for a long period. The environment temperature may be too high. The doors may be opened frequently or even they are left open. The temperature control knob setting in (4-5) state may increase the working time of compressor.
5. Disgusting odour happens. Food with strong odour should be packed tightly before being put inside the appliance. Please check whether there is any deteriorated item or whether the liners are left dirty for a long time.
6. Water leaks from the bottom of the refrigerator. The drain tube is jammed. Please use a proper tool to solve it.
7. Heavy frost occurs on the rear of the appliance. Putting humid or hot food into the appliance may cause this problem. Or it may be caused by the heavy environment moisture.

9

The follow cases are not malfunction

1. Moisture may form dew on the outside of the product during the humid season, just get it wiped.
2. The flow of refrigerant through the pipeline coil can cause a bicker.
3. It is normal that the sides of product get warm as a result of the cooling pipeline working.
4. The frame of the appliance will be warm during working by the defrost pipeline inside it.

Please check the points above first. If the supply cord is damaged, it must be replaced by the manufacturer, its service agent or similarly qualified persons in order to avoid a hazard.

SPECIFICATIONS AND PARAMETERS

Climate class	T	
Electric shock protection type	I	
Capacity (cu. ft.)	Freezer	2.65
	Refrigerator	9.36
Voltage (V)	115	
Frequency (Hz)	60	
Current (A)	1.2	
Voice [dB(A)]	≤ 45	
Energy consumption (kW.h/24h)	0.948	
Refrigerant	R600a/1.41oz	
Weight (lbs)	134.5	
Interior temperature (F)	Freezer	≤ 5
	Refrigerator	32~46.4
Dimension (inch)	Width	23.58
	Depth	27.68
	Height	64.84

PACKING LIST

Parts	Number
Shelve	4pcs
Crisper glass cover	1pcs
Vegetable crisper	1pcs
Rod	5pcs
Cola bar	3pcs
Bottle protector	2pcs
Owner's manual	1pcs

Note: Products are subject to improve from time to time, any changes in parts without further notice.

10